

Brand AXOR
 Art. Name **AXOR ShowerSolutions** Overhead shower 220 1jet EcoSmart+
 Art. Nr. 35388140
 Surface Brushed Bronze

Product picture



Features

- shower head size: 220 mm
- spray type: Rain
- flow rate Rain spray at 3 bar: 5,6 l/min
- function from: 2,6 l/min
- maximum flow rate at 3 bar: 5,6 l/min
- minimum flow pressure: 0,6 bar
- overhead shower angle adjustable
- material spray disc: metal
- overhead shower removable for cleaning
- installation: ceiling or wall
- connection thread: G 1/2
- suitable for continuous flow water heaters
- EU taxonomy: max. 6 l/min - Substantial Contribution (SC) possible

Drawing

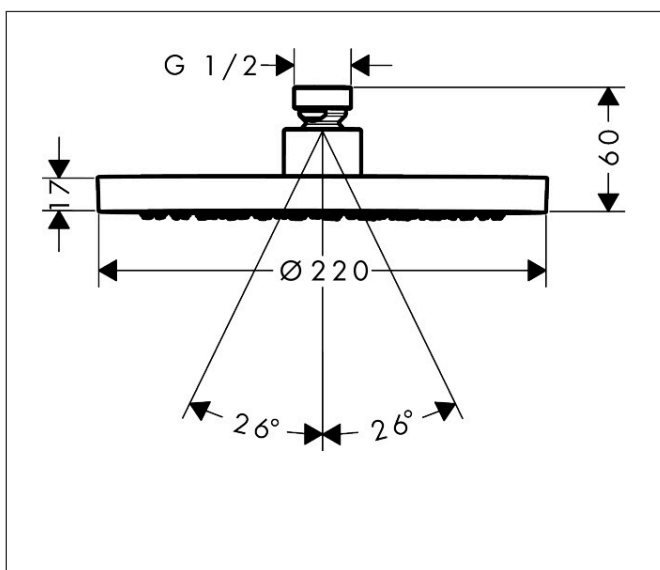

Technology









Spray Types



Brand AXOR
 Art. Name **AXOR ShowerSolutions** Overhead shower 220 1jet EcoSmart+
 Art. Nr. 35388140
 Surface Brushed Bronze

Required parts (choose one)

Product picture	Art. Name	Art. Nr.
	AXOR AXOR ShowerSolutions Ceiling connector 100 mm Brushed Bronze	26432140
	AXOR AXOR ShowerSolutions Ceiling connector 300 mm Brushed Bronze	26433140
	AXOR AXOR ShowerSolutions Shower arm 390 mm Brushed Bronze	26431140
	AXOR AXOR ShowerSolutions Ceiling connector 100 mm softsquare Brushed Bronze	26965140
	AXOR AXOR ShowerSolutions Shower arm 390 mm softsquare Brushed Bronze	26967140
	AXOR AXOR ShowerSolutions Ceiling connector 300 mm softsquare Brushed Bronze	26966140

Brand AXOR
Art. Name **AXOR ShowerSolutions** Overhead shower 220 1jet EcoSmart+
Art. Nr. 35388140
Surface Brushed Bronze

Flow chart

